

Working Paper No. 2003-02

**DYNAMICS IN REPEAT
IMPRISONMENT:
Utilising Prison Census Data**

Terry Rawnsley

June 2003

ABS Catalogue No. 1351.0

EMBARGO: 11:30AM (CANBERRA TIME) June 27 2003

Working Paper No. 2003/02

Dynamics in Repeat Imprisonment: Utilising Prison Census Data

Terry Rawnsley

June 2003

This Working Paper Series is intended to make the results of current research within the Australian Bureau of Statistics available to other interested parties. The aim is to present accounts of new developments and research or analysis of an experimental nature, so as to encourage discussion and comment.

The views expressed in this paper are those of the author(s) and do not necessarily represent the views of the Australian Bureau of Statistics. Where quoted or used, they should be clearly attributed to the authors.

ABS Catalogue No. 1351.0

Contents

1	Abstract	1
2	Introduction	2
3	Data	3
	3.1 Data quality	
	3.2 Imprisonment which is not recorded by the Prison Census	
4	Analysis of the Prison Census	9
	4.1 Descriptive statistics	
	4.2 Criminal career	
	4.3 Factors which may be associated with multiple imprisonment	
5	Conclusions	20
6	References	21

Further information

The ABS welcomes comments on the experimental work presented in this paper. Comments can be directed to Terry Rawnsley on Canberra 02 6252 6307 or e-mail <terry.rawnsley@abs.gov.au>.

Note

The views expressed in this paper are those of the author and do not necessarily represent the views of the Australian Bureau of Statistics (ABS). Where quoted or used, they should be clearly attributed to the author.

1 Abstract

One of the goals of any correctional system is to reduce the number of prisoners who are repeatedly imprisoned. A period of imprisonment may reduce an individual's willingness to consider re-offending and therefore being imprisoned again. However, due to a number of underlying variables, a period of imprisonment may in fact increase the probability of future imprisonment. In this context, prisoners with multiple imprisonment episodes pose a problem worth investigating. This paper reports analysis of aspects of prisoners with multiple prison spells based on the Prison Census.

The Prison Census extracts selected information from administrative data maintained by corrective services agencies in each state in Australia. The Prison Census collects social and sentencing information. Time series of micro data exist from 1993 to 2001. By combining the Prison Censuses across this period, a longitudinal dataset can be constructed. Analysis of this dataset can help explain the dynamics affecting individuals who are repeatedly imprisoned.

This work is the result of a joint project between the Australian Bureau of Statistics Analysis Branch and the National Centre for Crime and Justice Statistics.

Acknowledgments

The author wishes to thank the following people, who provided comments on the work reported in this paper: Alan Mackay, Toni Makkai, Chris Libreri, Frank Morgan, John Walker, Simon Eyland, Robert Tanton, Ken Tallis, Godfrey Lubulwa and Karen Gelb.

The author would also like to thank for Jo Dover, Nick Skondreas, Catherine Andersson and Jan Schumacher for assistance with data queries related to the Prison Census.

Notwithstanding the contributions of all those noted above, responsibility for any errors or omissions remains with the author.

2 Introduction

Reducing the number of prisoners who are repeatedly imprisoned can be seen as one of the objectives of any correctional system. A period of imprisonment may deter individuals from re-offending and therefore being imprisoned again. However, a period of imprisonment may in fact increase the probability of future imprisonment. In this context, prisoners with multiple imprisonment episodes pose a problem worth investigating. A better understanding of this group of individuals could lead to more informed decision making.

Despite limitations in the data the Prison Census is a useful dataset to help explore the characteristics of prisoners with multiple imprisonment episodes. The Prison Census extracts selected information from administrative data maintained by corrective services agencies in each state in Australia. A variety of data items are collected, covering social information (such as age, education, marital status) and sentencing information (such as most serious offence, date of release). By combining the Prison Censuses from 1993 to 2001 a longitudinal dataset can be constructed. Analysis of this dataset can help explain the dynamics of individuals with multiple prison spells.

In this paper prisoners who are repeatedly imprisoned are referred to as having multiple prison spells or as having prior imprisonment rather than as recidivists. Recidivist is a term regularly used in criminology which refers to individuals who repeatedly commit crimes. Individuals with multiple prison spells can be seen as a subgroup of the recidivist population.

Figure 1 outlines a simple model of the different paths criminals may take. The measurement of recidivism would require data from all levels in the flow chart. However, prior imprisonment only refers to a sub-population of prisoners who have had prison episodes previously.

The grey box represents the data collected on the Prison Census. Repeatedly imprisoned individuals leave prison and return to criminal activity, then they are arrested again by police and appear before the court before being sentenced to another period of imprisonment. Therefore, this project is only able to focus on repeated imprisonment rather than the broader concept of recidivism.

Figure 1: Potential Paths in Criminal Activity

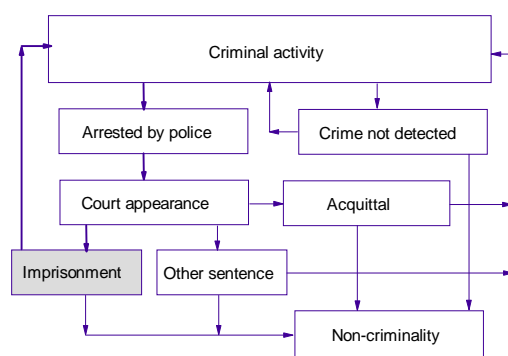

The rest of the paper is divided up as follows. Section 3 outlines the Prison Census data and the quality of the data. Section 4 presents descriptive statistics on the prison population and conducts analysis on the characteristics of prisoners with multiple prison spells. The conclusions of the paper are presented in section 5.

3 Data

The Prison Census is conducted on 30 June in each year. The Australian Bureau of Statistics (ABS) has been collecting this data since 1994 based on a methodology developed by the Australian Institute of Criminology. A time series of micro data exists from 1993 to 2001.

The Prison Census extracts selected information from administrative data maintained by corrective services agencies in each state. A variety of data items are collected covering social and sentencing information. The Prison Census is published by the ABS in *Prisoners in Australia* (Cat No 4517.0).

Every prisoner within each state is assigned a unique identification number. This unique identification number allows individual prisoners in each state to be tracked over time. By combining the Prison Censuses from 1993 to 2001 a longitudinal dataset can be constructed.

Within most longitudinal data there is the problem of “left censoring”. It is unknown what has happened to prisoners prior to the 1993 Prison Census. The Prison Census does provide one piece of information regarding prisoners’ previous imprisonment experience. The Prison Census collects any “Known Adult Imprisonment” for each prisoner. This is defined as “*Any known previous imprisonment that occurred under sentence in a gazetted adult prison.*” Therefore, any imprisonment in a juvenile detention center will not be recorded by the Prison Census.

The prior imprisonment flag can be used to identify prior imprisonment experience of the prisoner. This enables the identification of individuals who appear only once in the Prison Census between 1993 and 2001, but who had a pre-1993 prison spell, as having repeated imprisonment.

There is also the issue of the Prison Census being conducted only once a year. If a prisoner is imprisoned for only a short period of time in between two censuses there will be no record of such a prisoner. A large percentage of prison sentences are less than 12 months in duration, so the Prison Census may under estimate the number of imprisonment spells. This issue is further explored in Section 4.2.

The next section evaluates the quality of the Prison Census data and outlines some conceptual problems with its collection.

3.1 Data quality

The reliability of any analysis is heavily dependent on the quality of the underlying data. The Prison Census is by-product administrative data. As the prison administrative system is not specifically designed to collect this information, it is important that an assessment is made of the quality of the data. Drawing conclusions based on analysis of poor quality data is fraught with danger.

A number of tests have been applied to the Prison Census data to assess its quality:

Item non-response rate

The first test is to observe the percentage of item non-response. Item non-response for a given variable refers to the situation where the value for the variable is missing or not stated. The item non-response rate gives some idea of the coverage of the prison population that the variable has. Variables with high item non-response rates can be seen as unreliable as they may not be representative of the whole population.

Consistency of time invariant variables

For a given prisoner, time invariant variables such as gender, Indigenous status and country of birth should have the same value over time. By comparing a prisoner's responses from each Prison Census the consistency of the variable can be assessed. Changes over time in these types of variables raise serious concerns about the quality of the Prison Census data.

Clarity of definition

The third test is to assess how clearly defined is the underlying concept that the variable is trying to measure. This will be particularly important for items which are self reported by prisoners (for example, Indigenous status).

While none of these tests can produce a definitive quality assessment they collectively provide an informed assessment of how reliable any analysis using the variable will be. Table 1 outlines the quality of some of the variables on the Prison Census.

The overall quality assessment has been made based on the three tests outlined above and from input from the National Centre for Crime and Justice Statistics subject matter experts.

Table 1: Selected Prisoner Census Data Items

Variable	Non-response rate	% of prisoners with inconsistent variables	Overall quality assessment	Additional comments
State of court of sentence	0.0%	0.0%	Good	
Prisoner identifier	0.25%	0.5%	Good	The identifier cannot capture prisoners imprisoned in different states
Date of birth	0.0%	0.5%	Good	
Indigenous status	1.0%	1.0%	Good	Indigenous status on the Prison Census is in principle self identified
Marital status at receipt	6.4%	N/A	Good	
Employment status	47%	N/A	Poor (Fair excluding NSW)	NSW does not collect this item. If NSW is excluded then non-response falls to 12%
Known highest level of education	42%	N/A	Poor (Fair excluding NSW)	NSW does not collect this item. If NSW is excluded then non-response falls to 3.6%
Known adult imprisonment	Less than 0.5%	1%	Good	
Most serious offence	0.0%	1%	Good	Cannot collect all offences a prisoners is convicted of
Date aggregate sentence commenced	1%	1%	Good	Extracted straight from prison administration data

Poor = Cannot support reliable analysis.

Fair = Results of analysis should be treated with caution.

Good = Results of analysis are of a reliable nature.

N/A = It is possible for these variables to change over time.

By creating a longitudinal dataset, prisoners' details can be compared over time. This allows the dataset to be "cleaned" to some extent. For example, if a prisoner does not report their Indigenous status in one Prison Census but does report it in the following years then the later years' data can be used to impute the variable for the earlier year.

This technique can also be applied when different years produce inconsistent results for a given variable. For example, a prisoner with a sentence covering four censuses, may report no prior imprisonment in the first two years, and the fourth year but reports prior imprisonment in the third year. It is likely that the prior imprisonment reported in the third year is the result of an editing or collection error. Therefore, the third year value can be reset to no "prior imprisonment".

The result of this cleaning may be to produce slightly different results from those published Prisoners in Australia (Cat. No. 4517.0). All the results reported in this paper are based on the data set cleaned by the project team.

3.2 Imprisonment which is not recorded by the Prison Census

As the Prison Census is conducted only once a year it is biased towards long stay prisoners (imprisonment over 12 months) as they have more chance of being collected by the Prison Census compared to a prisoner with a shorter sentence, say 1 month. A prisoner with a short sentence of 1 month has only a 1 in 12 chance of being included in the Prison Census. As a result of this, if a prisoner is imprisoned for only a short period of time in between two censuses there will be no record of this prisoner. As a large percentage of prison sentences are less than 12 months in duration then the Prison Census may under estimate the number of imprisonment spells. Table 2 outlines this problem. The entries in bold are not observed by the Prison Census.

Table 2 Example of prison spells missed by the Prison Census.

Prisoner ID	Year	Prior imprisonment	Date of receipt	Date of release	Spells that are observed by the Prison Census	True number of prison spells
1	1993	No	June 1992	Sept 1993	First	First
	1994	Yes	Jan 1994	Dec 1994	Second	Second
	1995	Yes	Jan 1995	Mar 1995		Third
	1997	Yes	July 1996	Nov 1997	Third	Fourth
2	1982	No	Jan 1981	Dec 1982		First
	1985	Yes	Feb 1985	Feb 1992		Second
	1993	Yes	June 1993	Aug 1993	Second	Third
	1994	Yes	July 1994	May 1995		Fourth
3	1999	No	July 1999	Aug 1999	None	First

Prisoner 1 enters prison for the first time (the prior imprisonment flag indicates there is no previous imprisonment) in June 1992 and is released in September 1993. Prisoner 1 then returns to prison for his second spell in 1994. Prisoner 1 then has a brief prison spell in 1995 which is not recorded on the Prison Census. Prisoner 1 is then imprisoned for a fourth spell (which is recorded by the Prison Census) in 1996. Prisoner 1 has only three of their four prison spells captured by the Prison Census.

Prisoner 2 is imprisoned twice before 1993. Prisoner 2 is then imprisoned a third time in 1993. This is the first time the prisoner is included the Prison Census. As the prior imprisonment flag is positive then this can be seen to be at least the prisoner's second spell. The prisoner is imprisoned for a fourth time which is not collected by the Prison Census. Out of Prisoner 2's four spells only one can be definitively identified using the Prison Census and it is also known that at least one other spell exists prior to 1993.

Prisoner 3 is imprisoned for the first time in 1999. This prisoner is not collected by the Prison Census.

It is possible to assess how great the problem of missing prison spells is in the Prison Census. An estimate of the number of prisoners (or prison spells) not being observed in the Prison Census is constructed.

As shown in Table 3 by combining the Prison Census and inflow data published in Corrective Services (Cat. No. 4512.0) an estimate of the number of individuals imprisoned within a given financial year can be constructed. The Prison Census provides the number of prisoners at the start of the financial year. The inflow data provide the number of prisoners received into prison custody each quarter.

Table 3: Total number of prisoners received into prison in 2000/2001.

Prison Census 2000	Sep 2000	Dec 2000	Mar 2001	Jun 2001	Total
21,615	7,642	6,866	6,251	6,624	48,998

In 2000/2001 there were at most 48,998 individuals imprisoned. The term "at most" is used as the inflow data is based on aggregate data on imprisonment episodes. For example, a prisoner could be imprisoned in September 2000 for one month. The same prisoner could be imprisoned again in March 2001 for one month. This prisoner will appear twice in the aggregate data. The total of 48,998 may include prisoners who are double counted due to this problem.

The 48,998 is the number of prisoners through the prison system within the 2000/01 financial year. An estimate can be made of the number of prisoners observed over the financial year in the Prison Census.

The 2000 Prison Census provides the starting point. The "inflow" data in this case is derived from the 2001 Prison Census based on the date of receipt variable. As shown in Table 4, 1,287 prisoners were imprisoned in the September quarter of 2000 and were still in prison for the 2001 Prison Census.

The 6,355 (7,642-1,287) difference between the September quarter in Tables 3 and 4 is the number of prisoners who were imprisoned in the September quarter 2000 and released before the 2001 Prison Census. The closer the receipt date to the Prison Census the higher the coverage. In total 35,016 prisoners are included in either the 2000 or 2001 Prison Censuses.

Table 4: Total number of prisoners observed by the Prison Census in 2000/2001.

Prison Census 2000	Sep 2000	Dec 2000	Mar 2001	Jun 2001	Total
21,615	1,287	1,941	3,638	6,535	35,016

Figure 2 shows the percentage of the total number of prisoners collected by the Prison Census in each financial year. In almost every year (with the exception of 1998/99) at least 60% of the prison population is captured by the Prison Census. In 2000/2001 at least 71.5% (35,016 out of 48,998) of prisoners were captured by the Prison Census.

FIGURE 2: COVERAGE OF THE PRISON CENSUS

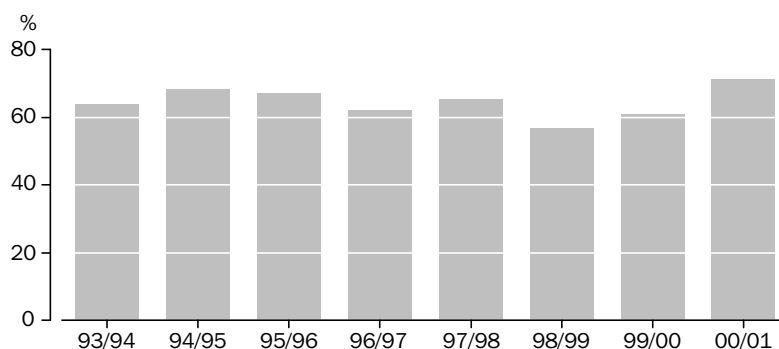

1. Data was not available for NSW between July and December 1997.
NSW data was estimated for this period in order to obtain Australian totals.

However, this graph cannot shed light onto the number of spells being missed by the Prison Census. For example, suppose a prisoner was received into prison in September of 2000 and released in November 2000 and was received into prison again in March 2001 and remains in prison until after the 30th of June.

The inflow data will count this individual twice while the Prison Census only once. As the inflow data is based on aggregate data it is not possible to determine if this "missing" observation is a different prisoner or an additional spell of a prisoner already collected in the Prison Census.

However, Figure 2¹ indicates that the Prison Census has a relatively good and constant coverage of the whole prison population and the results drawn from it can be seen as fairly reliable.

Another issue is that the unique identifier is only unique in each state and territory. If a prisoner is imprisoned in two different states, then he/she will be assigned two different unique identifiers. Therefore, the prisoner would not be identified as having multiple prison episodes.

Using the date of birth, gender and Indigenous status variables an estimate of how many prisoners may appear in two different states can be made. These three variables were chosen as they are believed to be of good quality and cannot change over time. For example, if two prisoners recorded on the Prison Census in two different states in different years and have the same day, month and year of birth, the same gender and report the same Indigenous status then it is quite likely that the two records are referring to the same individual.

Using these three variables 7% (that is, 3,000 prisoners may be appearing in two different states) of the Prison Census population maybe referring to the same individual. However, this can be seen as an upper bound, as it would be expected that a certain percentage of the population (and therefore the prison population) would have the same day, month and year of birth, the same gender, Indigenous status and live in different states. Considering all these factors interstate migration should not have a major affect on the analysis.

¹ To estimate the data for NSW, the proportion of NSW prisons to the rest of Australia in the previous year was applied to the 1997/1998 data.

4 Analysis of the Prison Census

This section is split into three parts. The first provides some descriptive statistics on the prison population. The second focuses on the different types of offences prisoners are imprisoned for and tests for the presence of a “criminal career”. The third part provides some analysis of the factors which may explain repeated imprisonment.

4.1 Descriptive statistics

Figure 3 shows the number of prisoners in Australia and the number of those who have had prior imprisonment. There has been a steady increase in the prison population since 1993. In 1993 the total prison population was 15,866 compared to 22,276 prisoners in 2001, an increase of over 40%. During the same period the prison population with prior imprisonment has increased by almost 42% from 8,991 to 12,603.

FIGURE 3: PRISON POPULATION 1993-2001.

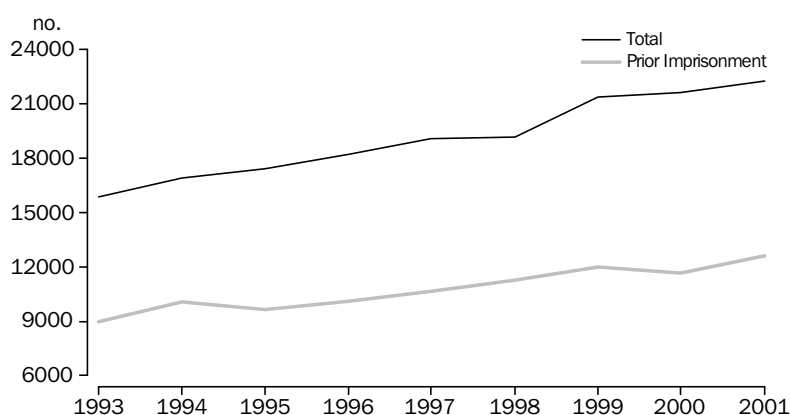

In total 88,060 individuals are identified on the Prison Census between 1993 and 2001. As shown in Figure 4, 37,610 prisoners have one spell which is observed by the Prison Census, and 35,460 experienced at least two prison spells between 1993 and 2001. Only 1,888 prisoners experienced 5 or more spells.

FIGURE 4: NUMBER OF PRISONERS BY OBSERVED NUMBER OF SPELLS

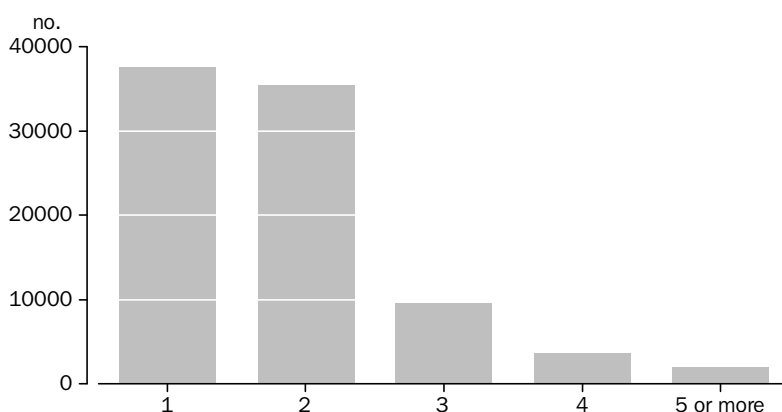

Figure 5 presents the percentage of prisoners with prior imprisonment in each year. The percentage of prisoners with prior imprisonment does not appear to follow any clear pattern with the rate ranging between 53.8% in 2000 and 59.4% in 1994.



Table 5 presents the Prison Census data for the 9 years with a summary of the prisoners with prior imprisonment. Working down the 1996 column as an example, there are 1603 prisoners with prior imprisonment who have been in prison since before 1993 and are still in prison in 1996. There are 631 prisoners who have been imprisoned since 1993 and are still in prison in 1996. There are 965 prisoners with prior imprisonment who have been in prison since 1994 and are still in prison in 1996. 2471 represents the number of prisoners with prior imprisonment who have been imprisoned since 1995. There are 4436 prisoners who have prior imprisonment who entered prison in 1996. In total at 30 June 1996 there are 10,106 prisoners with prior imprisonment compared to 8039 prisoners who were on their first spell.

Table 5 : Prisoners with & without prior imprisonment by year of Prison Census

Year	Prisoner Census Year								
	1993	1994	1995	1996	1997	1998	1999	2000	2001
Pre-1993	5169	3449	2352	1603	1497	805	689	458	389
1993	3799	2451	1099	631	512	323	265	166	153
1994	0	4144	2244	965	648	402	281	177	150
1995	0	0	3924	2471	999	554	388	225	165
1996	0	0	0	4436	2329	913	577	387	266
1997	0	0	0	0	4692	2893	1055	581	408
1998	0	0	0	0	0	5423	2909	991	597
1999	0	0	0	0	0	0	5916	2920	1001
2000	0	0	0	0	0	0	0	5756	3035
2001	0	0	0	0	0	0	0	0	6487
Total with prior	8968	10044	9619	10106	10677	11313	12080	11727	12644
Total without prior	6898	6860	7762	8039	8402	7872	9328	9928	9631
Total	15866	16904	17381	18145	19079	19185	21408	21655	22275
% with prior	56.5	59.4	55.3	55.7	56	59	56.1	53.8	56.8

As shown in Table 5 relatively few prisoners are imprisoned for the whole period between 1993 and 2001. Within the first two years the 1993 cohort of prisoners has been reduced dramatically. This reflects the fact that the majority of the prison sentences are for relatively short periods. Long term prisoners make up a small percentage of the population.

4.2 Criminal career

One research question that can be addressed using the Prison Census is how specialised is a criminal's career. A criminal's career may last a short period, perhaps a few years, or their whole lifetime. During their career do prisoners specialise in certain types of crimes or do they diversify into different types of criminal activity over time? For example, if prisoners are imprisoned for the first time for a relatively minor offence are they then subsequently re-imprisoned on future occasions for increasingly violent or sophisticated crimes?

This type of analysis should be conducted with caution when using the Prison Census. Not all imprisonment spells are observed by the Prison Census. For example, a prisoner imprisoned for the first time for driving offence, may then be imprisoned for robbery, assault and then murder. If the sentence for the robbery and the assault are served in between two censuses we are not able to observe them. Therefore, the criminal career we observe for the prisoner is a driving offence and then murder.

Furthermore only the most serious offence for a given imprisonment episode is recorded on the Prison Census. The most serious offence is defined as the offence for which the prisoner is sentenced to the longest period. For example, if a prisoner commits a break & enter and an assault, only the assault will be recorded. It is not possible to identify which prisoners may be imprisoned for more than one offence.

Despite these problems the Prison Census is helpful for investigating criminal careers. Even though there may be some prison spells missing those which are observed by the Prison Census should still provide enough of the offences committed by a particular prisoner to observe if they are specialising in a type of offence.

Figure 6 shows the potential paths for prisoners. In this simple model, prisoners may exit the prison system permanently or continue to be repeatedly imprisoned. During the 9 year period 88,060 individuals were imprisoned. After their first prison spell 37,610 prisoners did not return to prison, while 50,450 prisoners were re-imprisoned after their first prison spell. After the second prison spell 35,460 prisoners did not return to prison. 14,990 prisoners continued to be re-imprisoned after their second spell. Only 5,469 prisoners continued to be re-imprisoned after their third prison spell.

Figure 6: Paths in Prison Activity

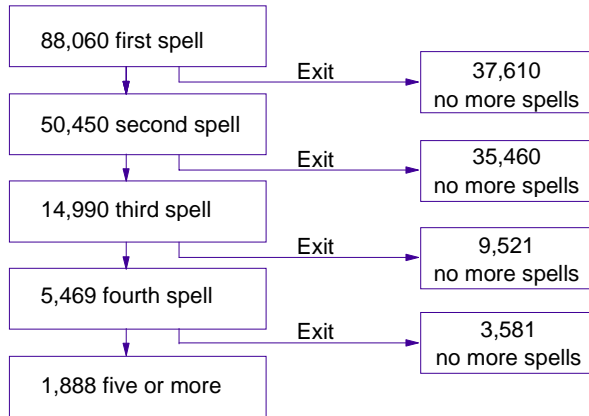

In Figure 6, the majority of prisoners exit the prison system after their second spell. It is not known if some of these prisoners will be re-imprisoned in the future. This problem is known as “right censoring”. If the time period of this study was longer, than potentially more prisoners would be imprisoned on a higher number of occasions.

Figure 7 shows the percentage of prisoners who were sentenced for a certain offence on their first imprisonment spell. Almost 40% of prisoners are imprisoned for assault, sexual offences and drug related crimes. 10% of prisoners are imprisoned for robbery, and a further 10% are imprisoned for break & enter.

FIGURE 7: DISTRIBUTION OF OFFENCES FOR THE 1ST PRISON SPELL

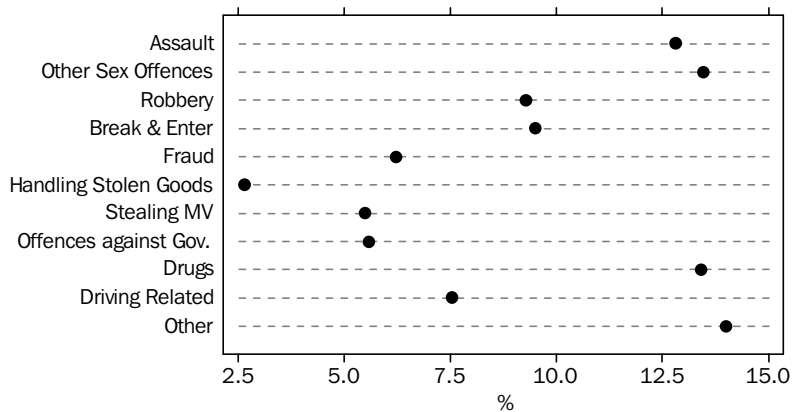

Prisoners who had at least four imprisonment spells are used to test how specialised criminal careers are. While prisoners with four spells represent a relatively small sample of the population (5,469 prisoners out of a total of 88,060) it provides enough prison spells to observe if a prisoner is specialising in one type of crime.

Shown in Figure 8 is the percentage of prisoners of who were imprisoned for the same crime (based on their first imprisonment) each time they are imprisoned. For all the offences the majority of prisoners are only imprisoned once for that offence. This may be due to the opportunistic nature of criminal activity resulting in prisoners committing a wide range of offences.

Robbery was one offence where prisoners appear to exhibit some degree of specialisation. 10% of prisoners were imprisoned for robbery for each of their four offences.

Break & Enter is also an offence which prisoners appear to exhibit some degree of specialisation. Over a quarter of prisoners who were first imprisoned for break & enter were imprisoned twice for the same offence. A further 6 percent were imprisoned for break & enter three out of the four imprisonment spells.

FIGURE 8: CRIMINAL CAREER BASED ON THE 1st OFFENCE

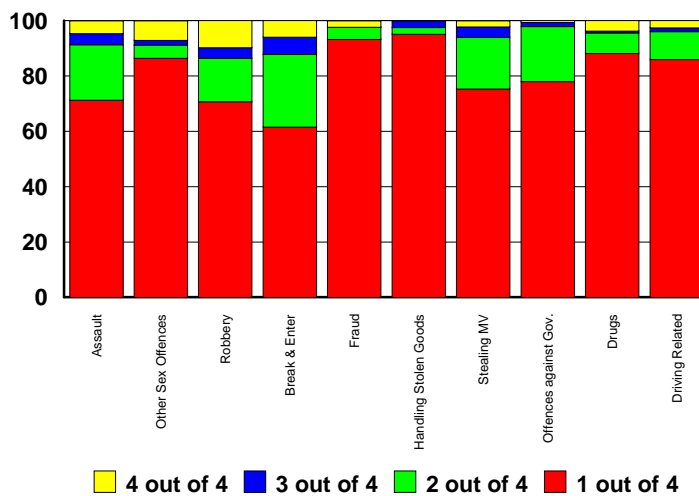

For the rest of the analysis of criminal careers only three offences were chosen to keep the analysis relatively uncluttered. Prisoners who were imprisoned for the first time for assault, break & enter or motor vehicle theft are used.

In Figure 9, the second, third and fourth offences of prisoners whose first offence was assault graphed. The x-axis relates to the percentage of prisoners for each offence. For example, of those prisoners who were imprisoned for the first time for assault, 16% were imprisoned for a second time for the same offence. For the third imprisonment 17% were imprisoned for assault, and 18% for the fourth offence.

FIGURE 9: FIRST OFFENCE : ASSAULT

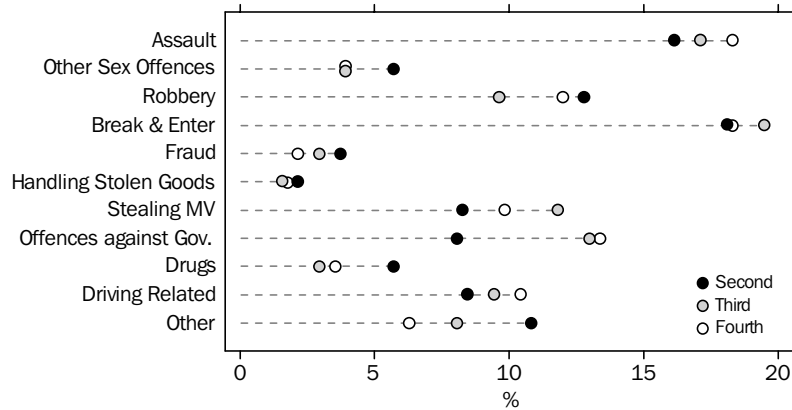

As shown in Figure 9 there does appear to be some relationship between the first and second offences. Of prisoners whose first offence was assault, 16% were imprisoned for a second time for the same offence. The percentage of prisoners imprisoned for assault steadily increases as the number of prison spells increases.

The largest percentage (18%) of prisoners were imprisoned for break & enter for their second offence. Break & enter is the largest offence for all spells except the fourth offence when it is only marginally lower than assault.

FIGURE 10: FIRST OFFENCE : BREAK & ENTER

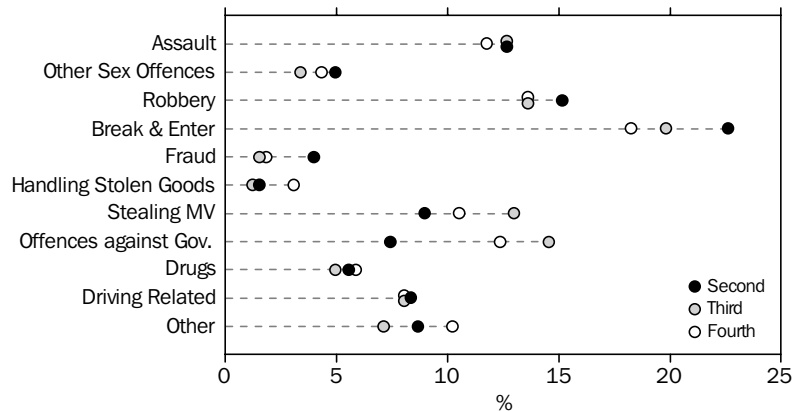

Similarly for break & enter (see Figure 10), almost a quarter of prisoners were imprisoned for the same offence on their first two spells. In total 24% of prisoners were imprisoned for the second time for robbery (15%) and motor vehicle theft (9%). The percentage imprisoned for break & enter steadily decreases as the number of prison spells increases. Robbery and stealing motor vehicles also appear “popular” offences for prisoners who had previously been imprisoned for break & enter.

Only 12% of prisoners with motor vehicle theft as their first offence were imprisoned for the same offence on their second prison spell (see Figure 11). A higher percentage were imprisoned for assault (13%) and break & enter (18%).

The percentage imprisoned for motor vehicle theft increases for the third (14%) and fourth spells (19%). Break & enter and robbery also appear to be “popular” offences for prisoners who were imprisoned for the first time for motor vehicle theft.

FIGURE 11: FIRST OFFENCE : STEALING MOTOR VEHICLE

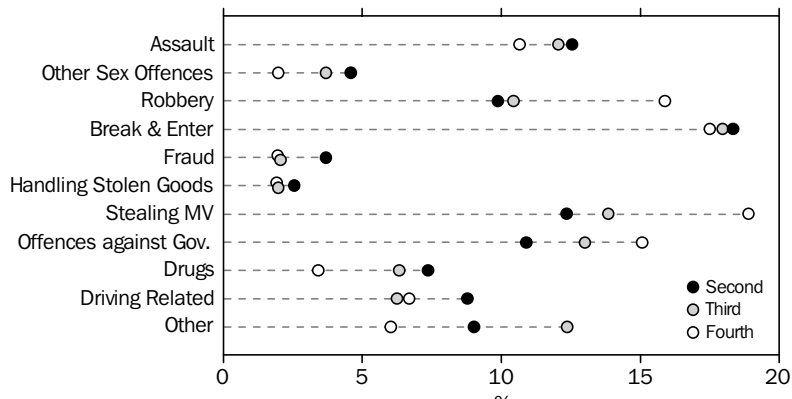

Table 6 presents in a tabular form the same information which is contained in the Figures 9-11. For example, reading across the first row (Assault), 12.54% of prisoners whose first imprisonment was for motor vehicle theft were imprisoned for assault on their second imprisonment. 12.69% of prisoners who were imprisoned for the first time for break and enter were then imprisoned for a second time for assault. 16.14% of prisoners with a first imprisonment for assault were then imprisoned a second time for that same offence.

Reading down the 2nd Offence column, 12.54% of prisoners whose first imprisonment was for motor vehicle theft were imprisoned for assault on their second imprisonment. 4.58% were imprisoned for a second time for other sexual offences. After their first prison spell for motor vehicle theft 9.88% were imprisoned on the second occasion for robbery.

The numbers in bold are where the first, second, third and fourth offences are identical. The percentage of prisoners imprisoned for the same offence as their first imprisonment is in higher (in 8 out of the 9 cases) than the percentage imprisoned for the first time for a different offence.

Table 6: Percentage of prisoners imprisoned for each offence

Offence	2nd Offence (%)			3rd Offence (%)			4th Offence (%)		
	MV	BE	AS	MV	BE	AS	MV	BE	AS
Assault (12.83%)	12.54	12.69	16.14	12.05	12.69	17.13	10.67	11.76	18.31
Other Sex Offences (13.47%)	4.58	4.95	5.71	3.68	3.41	3.94	1.98	4.33	3.94
Robbery (9.29%)	9.88	15.17	12.8	10.45	13.62	9.65	15.89	13.62	12.01
Break & Enter (9.51%)	18.35	22.6	18.11	17.97	19.81	19.49	17.5	18.27	18.31
Fraud (6.22%)	3.68	4.02	3.74	2.06	1.55	2.95	1.94	1.86	2.17
Handling Stolen Goods (2.65%)	2.55	1.55	2.17	1.98	1.24	1.57	1.92	3.1	1.77
Stealing MV (5.49%)	12.35	8.98	8.27	13.84	13	11.81	18.89	10.53	9.84
Offences against Gov.	10.9	7.43	8.07	13.01	14.55	12.99	15.06	12.38	13.39
Drugs (13.41%)	7.36	5.57	5.71	6.34	4.95	2.95	3.43	5.88	3.54
Driving Related (7.55%)	8.79	8.36	8.46	6.26	8.05	9.45	6.69	8.05	10.43
Other (14%)	9.02	8.68	10.83	12.37	7.13	8.07	6.05	10.22	6.29

MV: 1st Offence Motor Vehicle Theft

BE: 1st Offence Break & Enter

AS: 1st Offence Assault

The figure in brackets in the first column are the percentage of the whole population who were imprisoned for the first time for that particular offence. This helps provide an idea of how the subgroup (prisoners with four prison spells) chosen compares to the whole population. The difference between the two groups may be possibly explained by the different behaviour of the two groups but also the short time period of this study.

For example, the whole population has a higher percentage (13.41%) imprisoned for drug related offences than the subgroup with four prison spells. This can be attributed to drugs related offences having relatively long sentences. The longer the sentence the less opportunity a prisoner has to be imprisoned 4 times in the 9 year period.

This analysis indicates that the distribution of offence for the second, third and fourth offences does not appear to be dependent on the first offence.

There also does not appear to be a clear pattern of escalation in the type of offence prisoners are imprisoned for each time. Prisoners do not appear to be imprisoned for more serious offences each time they are imprisoned.

Given the relatively short period of time this study covers (1993-2001) prisoners with longer sentences have less opportunity to be imprisoned on multiple occasions. Given this, a longer times series may reveal a different story on the criminal career. This analysis has also focused in on a very small subgroup of the population (prisoners with four prison spells committing either assault, break & enter and stealing motor vehicles as their first offence). However, similar analysis conducted on prisoners with different first offences and different number of prison spells have produced similar results.

4.3 Factors which may be associated with multiple imprisonment

This section explores some of the factors which are associated with repeatedly imprisoned prisoners. Many of the explanatory variables which could explain repeated imprisonment (for example, childhood experiences) are not collected by the Prison Census. Indigenous status, marital status, labour force status (LFS) and highest level of education are variables which are collected by the Prison Census and may be associated with prisoners who are repeatedly imprisoned.

The relationship between marital status and the number of prison spells is interesting. In order to account for age differences between prisoners Figure 12 focuses on prisoners in the same age group (aged 35+). The percentage of prisoners who have never been married increases with the number of prison spells. The relative percentage of prisoners divorced also increases with the number of spells. Although the percentage of prisoners divorced appears to be the same for each group the higher percentage of never married means that there is a lower percentage who have had the opportunity to become divorced.

FIGURE 12: MARITAL STATUS & NO. OF SPELLS, Prisoners Aged 35+

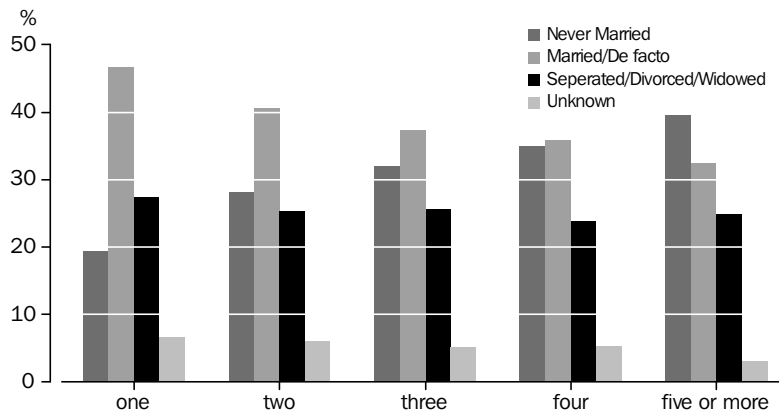

This phenomenon may be explained in a number of ways. The first is that as the number of prison spells increase, prisoners have less time to form and/or maintain relationships. Alternatively, due to the inability to form or maintain relationships they undertake more illegal activities. Marriage may provide individuals an incentive not to commit crimes.

Marriage can also be seen as a tie to the community. If an individual is unmarried and found guilty of an offence then they may be more likely to be sentenced to prison than a married individual. The absence of relationships may also be evidence of some other underlying variable affecting the prisoner.

FIGURE 13: EDUCATION LEVEL BY NUMBER OF SPELLS, Prisoners Aged 30-34

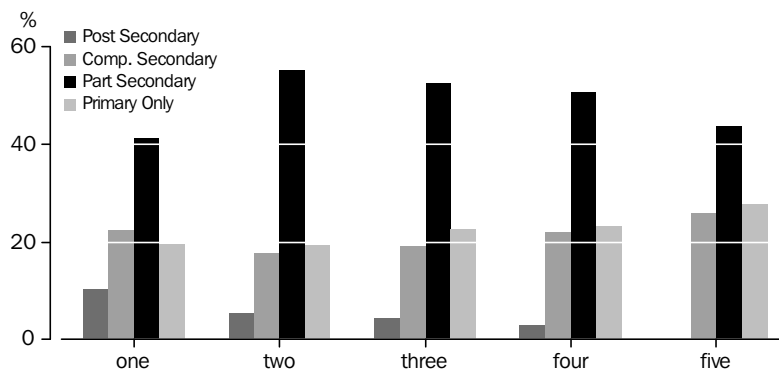

NOTE: Does not include NSW

Figure 13 shows that prisoners with more prison spells have on average lower levels of education. Only prisoners in the same age group (30-34) are used to ensure that any lifecycle effects are controlled for. Almost a quarter of prisoners aged 30-34 with 5 or more prison spells have only a primary school education. Virtually no prisoners with 5 or more spells have completed any post secondary school education. This is compared with 10% with post secondary school education for 1 spell prisoners. Figure 13 does not include prisoners in New South Wales which does not collect data on highest level of educational attainment

FIGURE 14: LABOUR FORCE STATUS BY NUMBER OF SPELLS

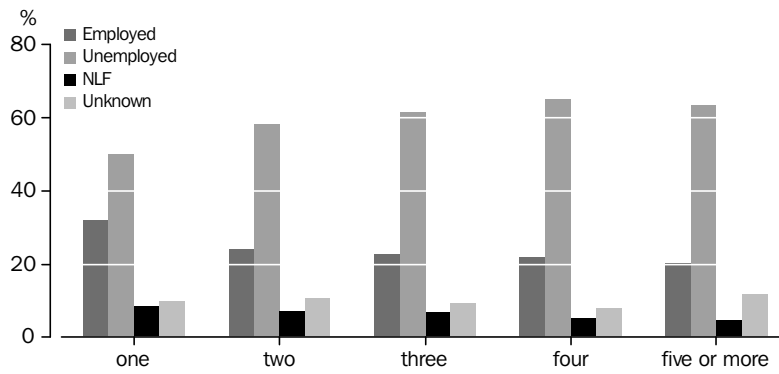

Note: Does not include NSW

As the number of prison spells increases the percentage of prisoners unemployed increases and the percentage employed decreases (see Figure 14). 32% of prisoners with one prison spell were employed before their reception into prison compared to 22% of prisoners with four spells. As Figure 14 does not include NSW prisoners and has a relatively high level of item non-response (12%) the results should be treated with caution.

Figure 15 shows the percentage of prisoners by number of spells and Indigenous status. 45% of non-Indigenous prisoners experienced only one spell in prison compared to 23% of Indigenous prisoners. This pattern is reversed when comparing the percentage of prisoners who experienced two spells. 51% of Indigenous prisoners have at least two spells in prison while 39% non-Indigenous experienced two spells.

FIGURE 15: % OF PRISONERS BY NUMBERS OF SPELLS & INDIGENOUS STATUS

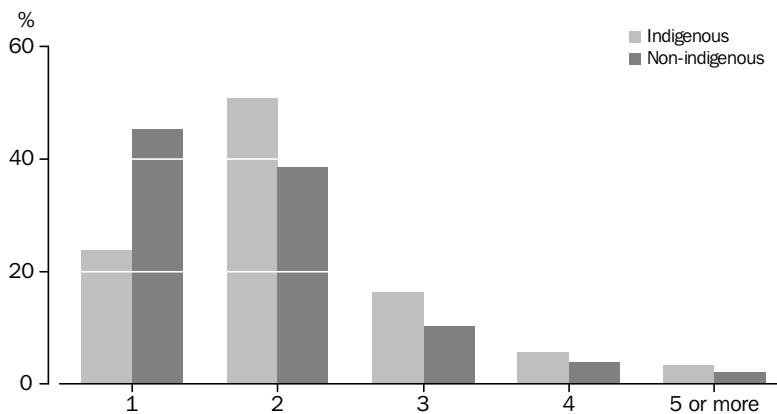

The higher percentage of Indigenous prisoners with a multiple of prison spells may be due to a number of underlying factors. Indigenous status alone is not enough to explain the occurrence of multiple prison spells. For Indigenous prisoners the higher number of prison spells might be due to Indigenous people having lower levels of education (see Figure 16) and lower levels of employment (see Figure 17).

FIGURE 16: EDUCATION LEVEL BY INDIGENOUS STATUS

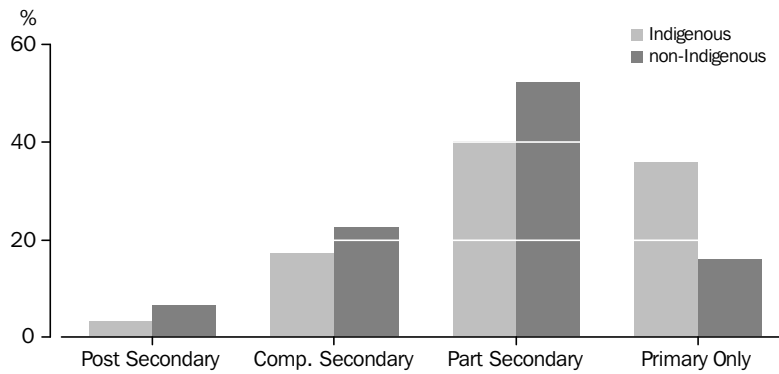

NOTE: Does not include NSW

Figure 16 shows that a higher percentage of non-Indigenous prisoners have completed post secondary school education, completed secondary school education and completed part of secondary school compared to Indigenous prisoners. 36% of Indigenous prisoners have only completed primary education compared to 16% of non-Indigenous prisoners. Figure 16 does not include prisoners in New South Wales which does not collect data on highest level of educational attainment.

FIGURE 17: LABOUR FORCE STATUS BY INDIGENOUS STATUS

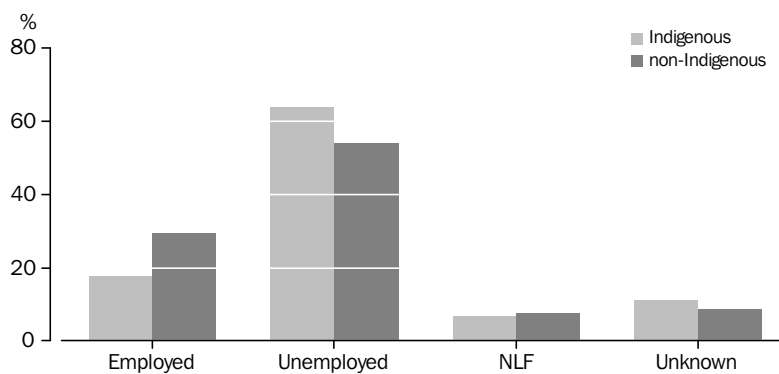

NOTE: Does not include NSW

Figure 17 shows that 30% of non-Indigenous prisoners were employed before their reception into prison compared to 18% of Indigenous prisoners. Conversely, 54% of non-Indigenous prisoners were unemployed before their reception into prison compared to 64% of Indigenous prisoners. Figure 17 does not include prisoners in New South Wales which does not collect data on employment status.

The differences between Indigenous and non-Indigenous education and employment patterns can explain some of the differences in the number of prison spells.

5 Conclusions

By combining the Prison Census from each year between 1993 and 2001 a longitudinal prison dataset can be constructed. The quality of the this dataset has been thoroughly assessed and a number of factors which are associated with prisoners who are repeatedly imprisoned have been explored. Preliminary results indicate that prisoners with more prisons spells are likely to have lower levels of education. Indigenous prisoners are more likely to be imprisoned more times than non-Indigenous prisoners.

There appears to be some evidence to suggest that some prisoners do specialise in certain types of crimes. However, they does not appear to be any clear escalation in the types of crimes prisoners are committing.

When interpreting these results it should be noted that the Prison Census does not collect all information on every prison spell of every prisoner. Also, the prison system represents the last step for criminal activity. There is the possibility that a prisoner may be released from prison and continue committing crimes yet not be arrested by police or if they are may receive a non-prison sentence.

However, the data collected by the Prison Census does provide a rich source of information on which more analysis can be undertaken which may further explore the reasoning behind repeated prison episodes. Further analysis that could be undertaken using the Prison Census includes:

- analysis of the relationship between Indigenous status and imprisonment.
- testing whether there is a relationship between the other variables on the Prison Census and repeated imprisonment.
- attempting to gain an insight into the effects of different sentencing practices on repeat offenders.
- attempting more sophisticated modeling on the longitudinal prison data set

References

- Agresti, A. and Finlay, B., 1999, *Statistical methods for the social sciences* 3rd edition, Prentice Hall, New Jersey.
- Australian Bureau of Statistics, 2002, *Prisoners in Australia*, Cat. No. 4517.0, ABS, Canberra.
- Australian Bureau of Statistics, 2002, *Corrective Services*, Cat. No. 4512.0, ABS, Canberra.
- Becker, G., 1968, *Crime & Punishment : An Economic Approach*, Journal of Political Economy Vol 76 169-217.
- Biles, D., 1990, *Remand Imprisonment in Australia*, Trends and Issues in Crime and Criminal Justice, Vol 27, Australian Institute of Criminology, Canberra.
- Carcach, C. and Grant. A., 1999, *Imprisonment in Australia: Trends in Prison Population & Imprisonment Rates 1982-1998*, Trends and Issues in Crime and Criminal Justice, Vol 130, Australian Institute of Criminology, Canberra.
- Carcach, C. and Leverett, S., 1999, *Juvenile Offending: Specialisation or Versatility*, Trends and Issues in Crime and Criminal Justice, Vol 108, Australian Institute of Criminology, Canberra.
- Chapman, B., Weatherburn, D., Kapuscinski. C., Chilvers, M., Roussel S., *Unemployment duration, schooling and property crime, 2002*, Crime & Justice Bulletin, Vol 74, New South Wales Bureau of Crime Statistics and Research, Sydney.
- Figlio, R., 1981, Delinquency careers as simple Markov processes, In Fox, J. A., *Models in Quantitative Criminology*, Academic Press, New York.
- Gottfredson, S., 1992, *Incapacitation strategies and the criminal career*, California: Department of Justice, Division of Law Enforcement.
- Hirschi, T. and Gottfredson, M., 1990, *A general theory of crime*, Stanford University Press, Stanford.
- Kempf, K., 1986, *Offence specialization: Does it exist?*, In Cornish, D and Clarke, R., *The Reasoning Criminal*, Springer-Verlag, New York.
- Langan, P., and Levin, D., *Recidivism of Prisoners released in 1994*, 2002, Bureau of Justice Statistics, USA Department of Justice.
- Thompson, B., *Recidivism in NSW : General Study*, 1995, New South Wales Department of Corrective Services, Sydney.
- Thomas, M., Hurley, H & James, C., *Pilot Analysis of Recidivism Among Convicted Youth and Young Adults*, 2002, Juristat Canadian Centre for Justice Statistics, Ottawa
- Shannon L., 1991, *Changing patterns of delinquency and crime : a longitudinal study in Racine*, Westview Press, Boulder.
- Tracy P., Wolfgang M. and Figlio R., 1990, *Delinquency careers in two birth cohorts*, Phenum Press, New York.

Wikstrom, P., 1987, *Patterns of crime in a birth cohort : Sex, age and social class differences*, Project Metropolitan Research Reports No. 24, University of Stockholm, Department of Sociology, Stockholm.

Walker, J., 1989, *Prison Sentences in Australia*, Trends and Issues in Crime and Criminal Justice, Vol 20, Australian Institute of Criminology, Canberra.

Walker, J., and McDonald, D., 1995, *The Over-Representation of Indigenous People in Custody in Australia*, Trends and Issues in Crime and Criminal Justice, Vol 47, Australian Institute of Criminology, Canberra.

Wikstrom P., 1991, *Urban Crime, Criminals and Victims: The Swedish experience in an Anglo-American Perspective*, Springer-Verlag, New York.

Wolfgang, M., Figlio, R. and Sellin, T., 1972, *Delinquency in a birth cohort*. Chicago: University of Chicago Press.

Wolfgang, M., Thornberry, T., and Figlio, R., 1987, *From boy to man, from delinquency to crime*. Chicago : University of Chicago Press.

FOR MORE INFORMATION...

- INTERNET* **www.abs.gov.au** the ABS web site is the best place to start for access to summary data from our latest publications, information about the ABS, advice about upcoming releases, our catalogue, and Australia Now-a-statistical profile.
- LIBRARY* A range of ABS publications is available from public and tertiary libraries Australia-wide. Contact your nearest library to determine whether it has the ABS statistics you require, or visit our web site for a list of libraries.
- CPI INFOLINE* For current and historical Consumer Price Index data, call 1902 981 074 (call cost 77c per minute).
- DIAL-A-STATISTIC* For the latest figures for National Accounts, Balance of Payments, Labour Force, Average Weekly Earnings, Estimated Resident Population and the Consumer Price Index call 1900 986 400 (call cost 77c per minute).

INFORMATION SERVICE

Data which have been published and can be provided within five minutes are free of charge. Our information consultants can also help you to access the full range of ABS information—ABS user-pays services can be tailored to your needs, time frame and budget. Publications may be purchased. Specialists are on hand to help you with analytical or methodological advice.

- PHONE* **1300 135 070**
- EMAIL* **client.services@abs.gov.au**
- FAX* 1300 135 211
- POST* Client Services, ABS, GPO Box 796, Sydney 2001

WHY NOT SUBSCRIBE?

ABS subscription services provide regular, convenient and prompt deliveries of ABS publications and products as they are released. Email delivery of monthly and quarterly publications is available.

- PHONE* 1300 366 323
- EMAIL* subscriptions@abs.gov.au
- FAX* 03 9615 7848
- POST* Subscription Services, ABS, GPO Box 2796Y, Melbourne 3001



2135100001034
ISSN 1320-5099

© Commonwealth of Australia 2003

Produced by the Australian Bureau of Statistics